

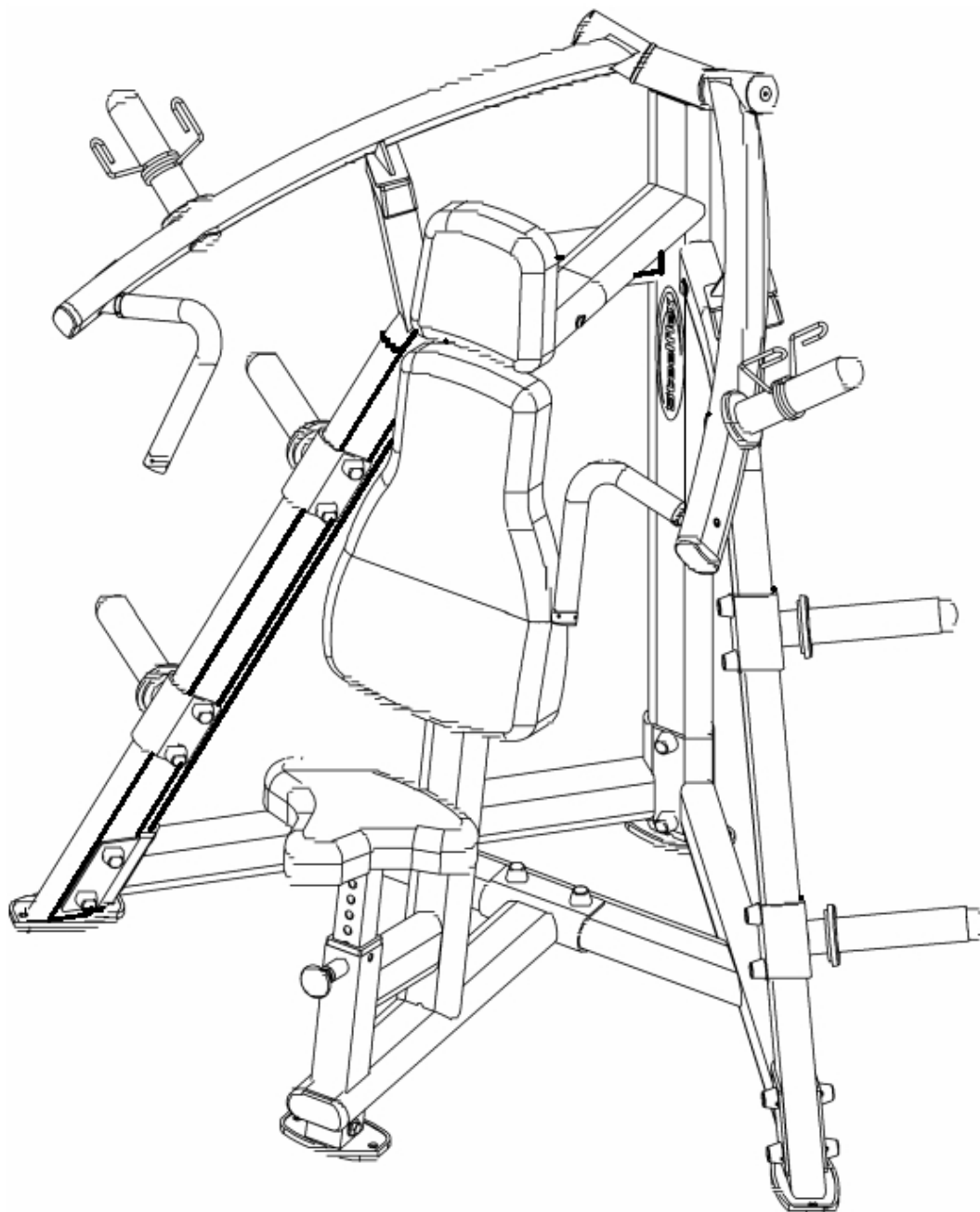

**UŽIVATELSKÝ MANUÁL – CZ**  
**IN 5094 Posilovací stanice Steelflex PLSP –ramena tlak**



# SPOJOVACÍ MATERIÁL

(nákres ve skutečné velikosti)

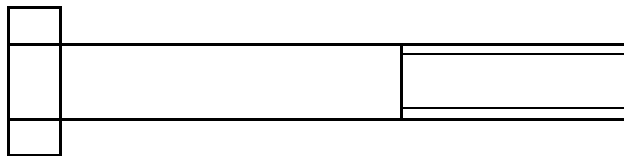
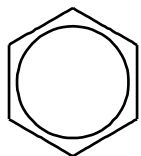

A1. M10x75 Šestihranný šroub ...9 kusů

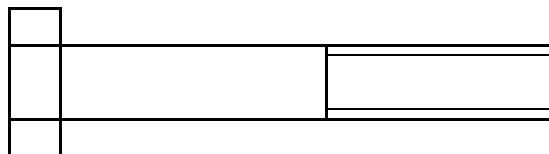
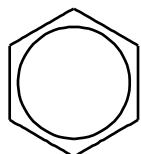

A2. M10x65 Šestihranný šroub...9 kusů

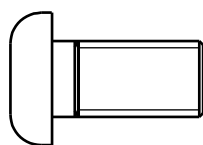
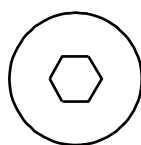

A3. M10x20 Imbusový šroub (celý závit)...4 kusy

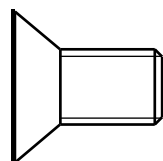
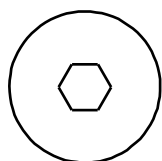

A4. M10x20 TAPER SCREW(celý závit)...2 kusy

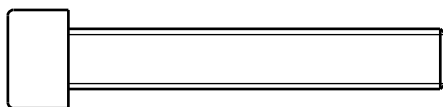
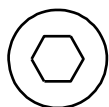

A5. M8x50 Imbusový šroub (celý závit)...4 kusy

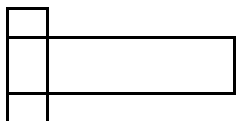
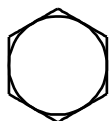

A6. M8x25 Šestihranný šroub...9 kusů

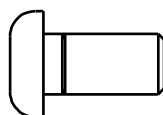
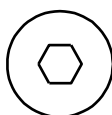

A7. M8x16 Imbusový šroub (celý závit)...4 kusy

mm

0

10

20

30

40

50

60

70

80

90

100

110

120

130

140

150

inch

0

1"

2"

3"

4"

5"

6"

# SPOJOVACÍ MATERIÁL

(náčrt ve skutečné velikosti)



A8. M5x5 Závrtný šroub ...8 kusů (Pre-installed)

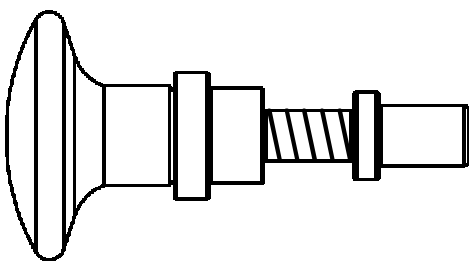
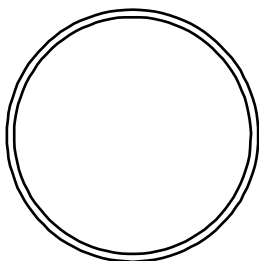

A9. 1/2"x92.5L Zajišťovací kolík (8250-065G)...1 kus (Pre-installed)

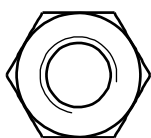

B1. M10 Samojistící matice...10 kusů

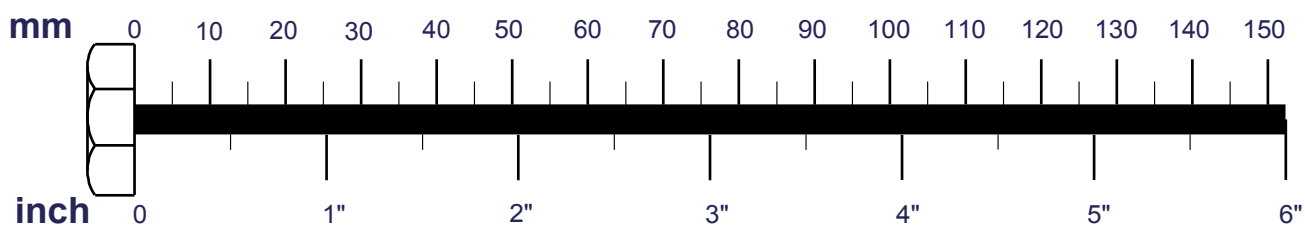

# SPOJOVACÍ MATERIÁL

(nákres ve skutečné velikosti)

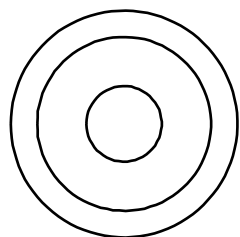

C1. M10 Talířová podložka (Ø30)...24 kusy

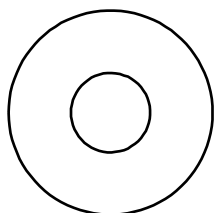

C2. M10 Podložka (Ø27)...6PCS(Pre-installed 2 kusy)

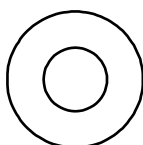

C3. M8 Prohnutá podložka ...2 kusy



C4. M8 Pružná podložka ...9 kusů

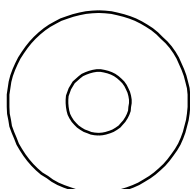

C5. M8 Podložka ...11 kusů

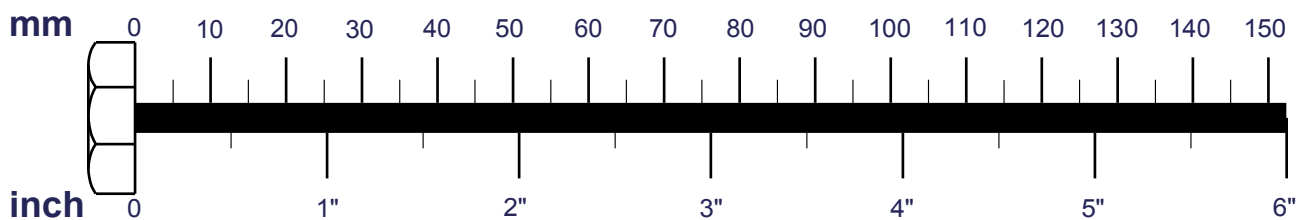

# DÍLY

A [1 kus]

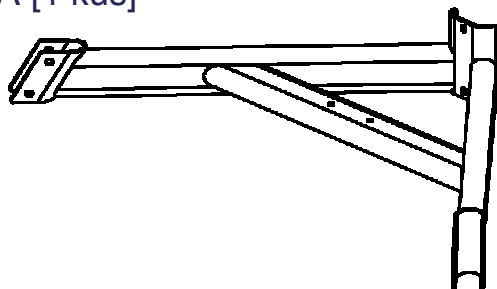

B [1 kus]

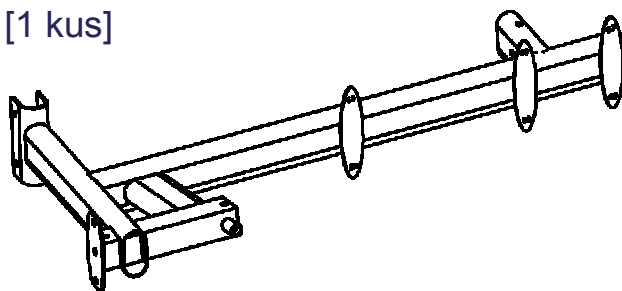

C [1 kus]

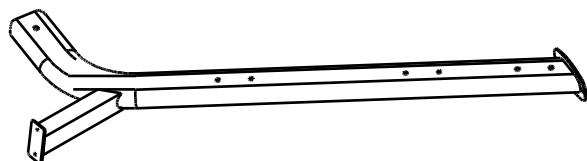

D [1 kus]

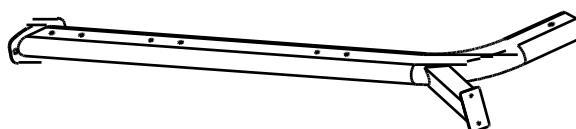

E [1 kus]

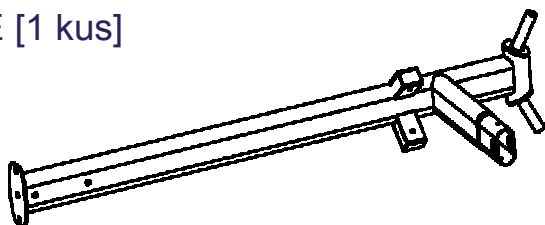

Q [1 kus]

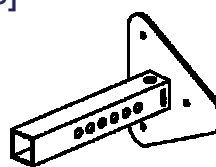

H [1 kus]

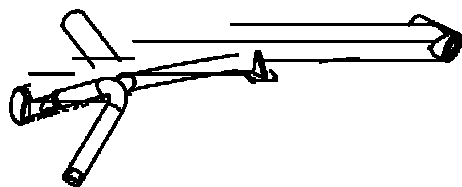

I [1 kus]

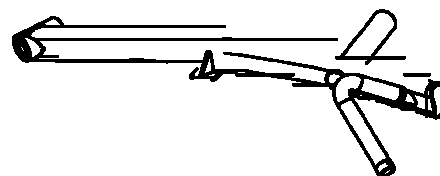

F [4 kusy]  
6730001

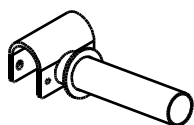

G [1 kus]  
8323188



M [1 kus]  
8830023  
(pre-installed)



J [1 kus]  
9111072

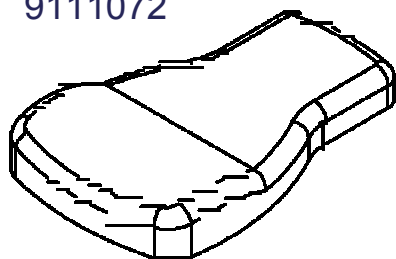

K [1 kus]  
9131025

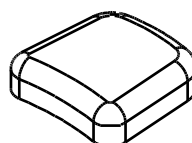

L [1 kus]  
9144016

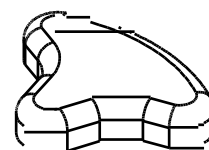

## DÍLY

D1. 40x80 Koncová krytka (9211-113) předmontováno .....	[2 kusy]
D2. Ø50 Koncová krytka (9211-020) .....	[2 kusy]
D3. Ø50 Koncová krytka (9211-074) .....	[6PCS]
D4. Koncovka (8130-248) .....	[2 kusy]
D5. Gumová podložka (9310-016) .....	[6PCS]
D6. Bezpečnostní objímka (OC-06) .....	[2 kusy]
D7. Gumový doraz (9310-077) .....	[2 kusy]
D8. 50x100 Koncová krytka (9211-114) .....	[2 kusy]
D9. Gumová podkládací destička (9310-076) .....	[4 kusy]
D10. Měděná podložka (8520-008) .....	[2 kusy]
D11. Nylonová vložka (9211-047) .....	[1 kus]
D12. Krytka hlavy šroubu (9212-026) .....	[24 kusů]
D13. Pěnový grip (9162-102) předmontováno .....	[2 kusy]
D14. Koncovka (8890-061) předmontováno .....	[2 kusy]
D15. Ložisko (8510-037) předmontováno .....	[4 kusy]
D16. Vymezovací vložka kladky (8530-009).....	[2 kusy]
D17. Koncovka (8130-254) předmontováno.....	[2 kusy]

D1



D2



D3



D4



D5

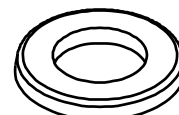

D6

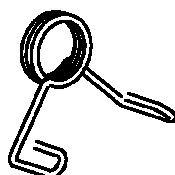

D7

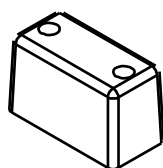

D8



D9

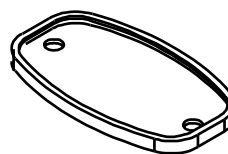

D10



D11

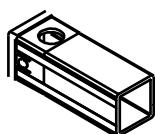

D12



D13

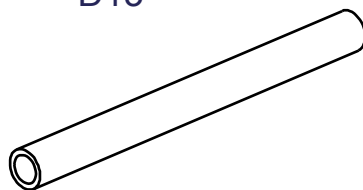

D14



D15



D16



D17



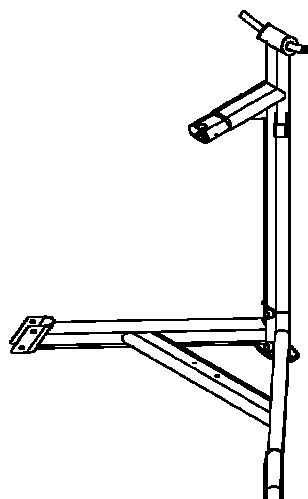

Krok 1: dokončená montáž

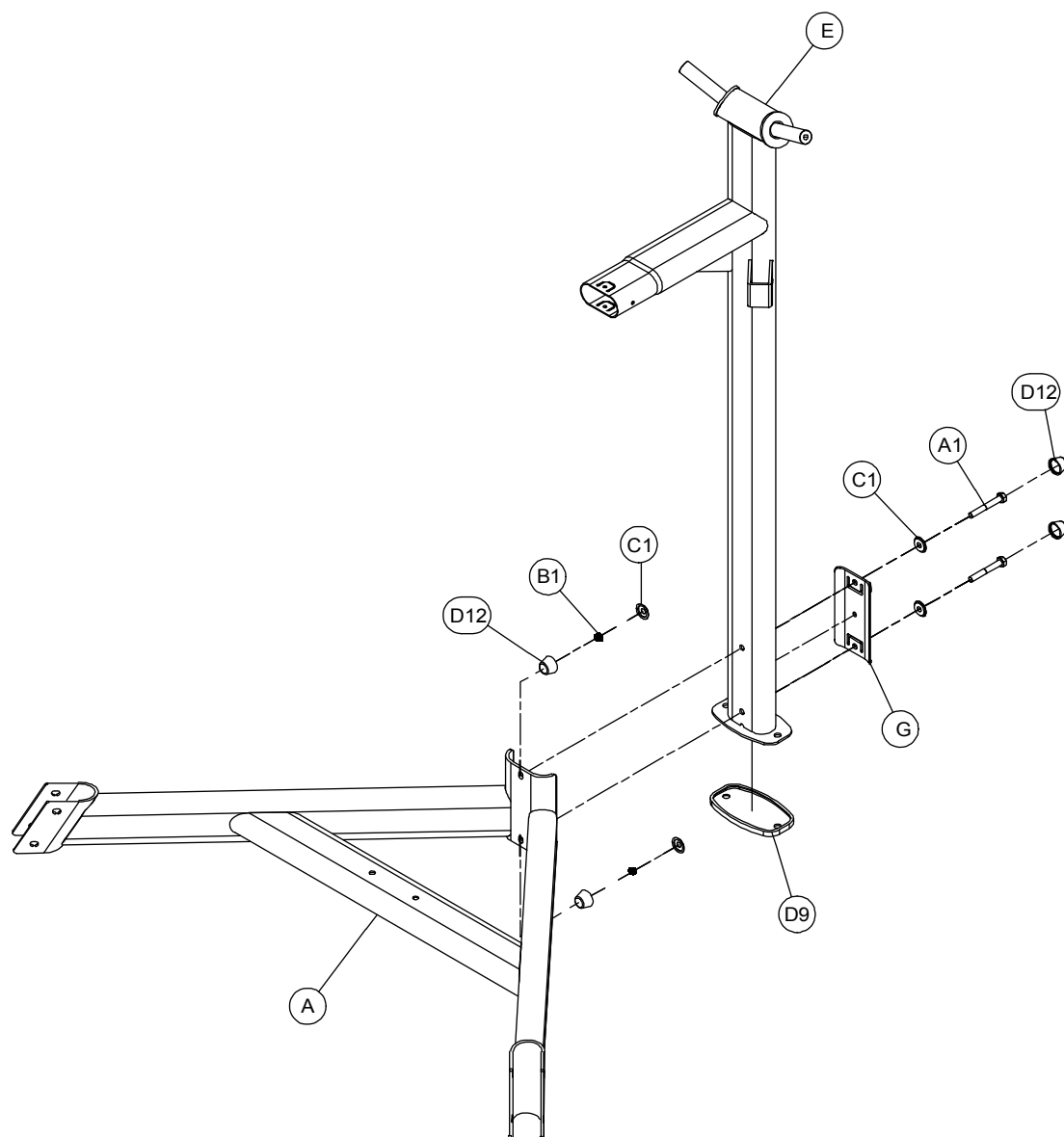

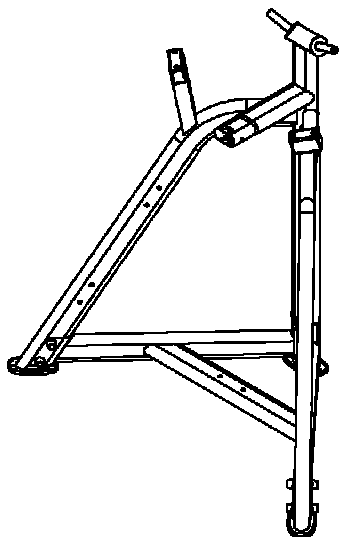

Krok 2: dokončená montáž

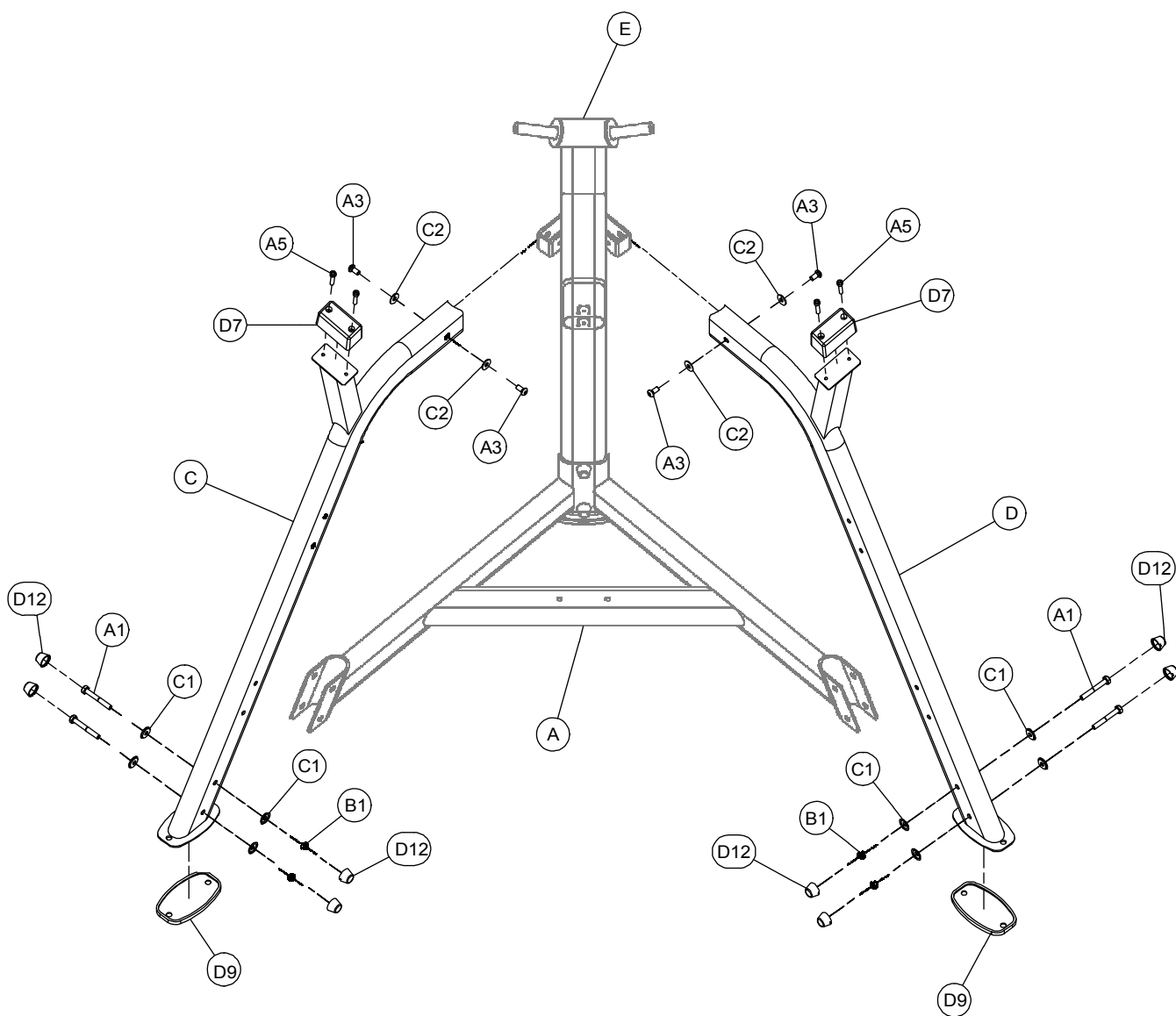



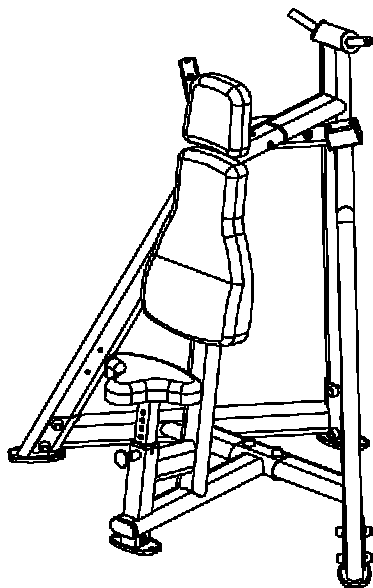

Krok 3: dokončená montáž

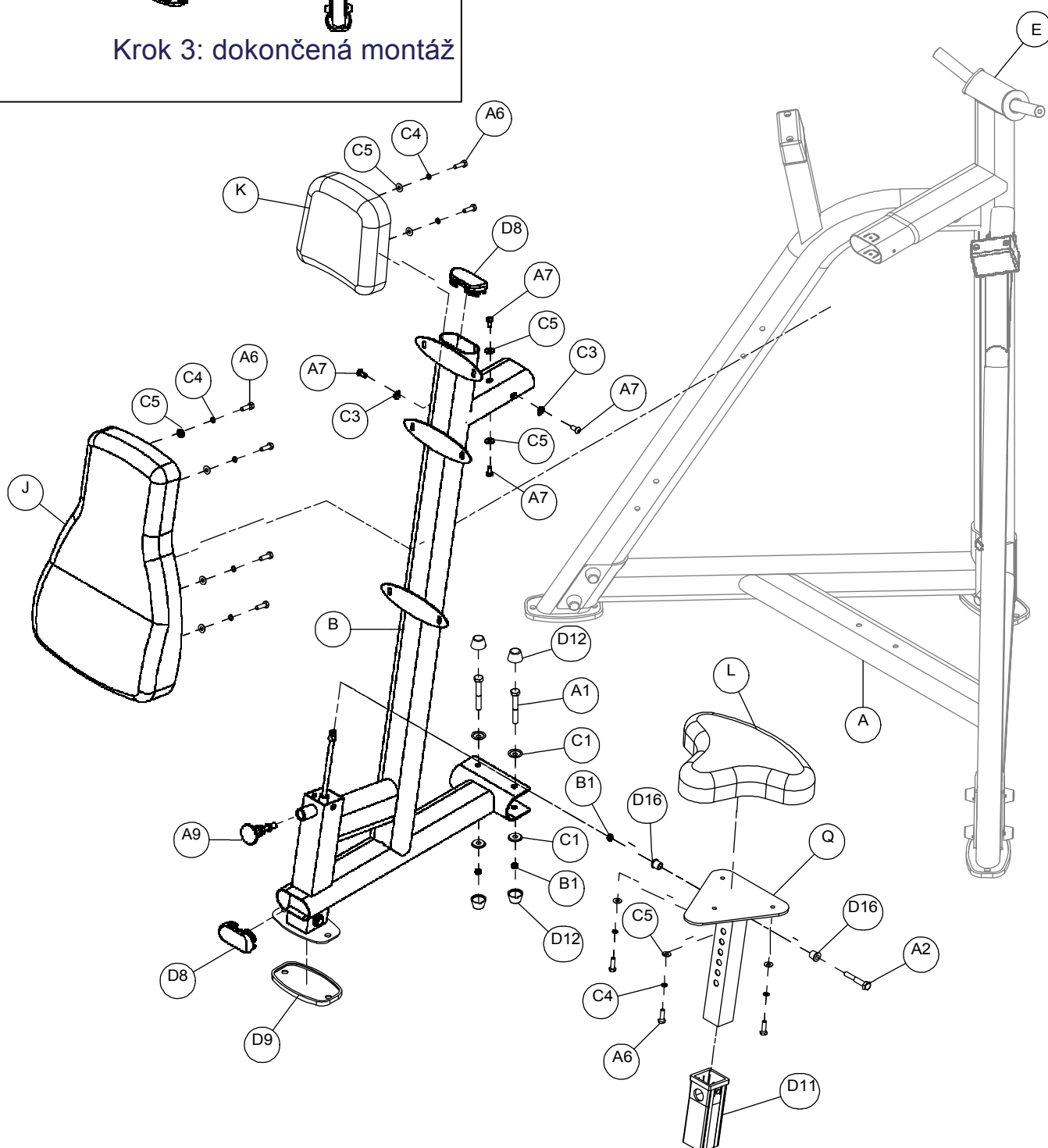

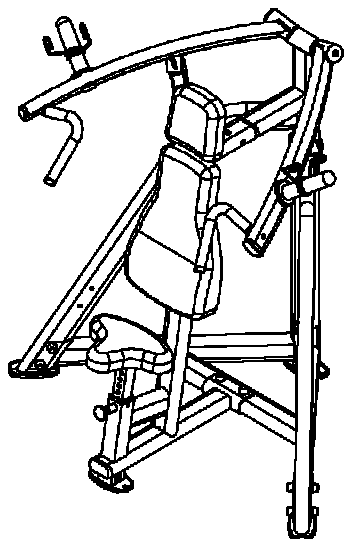

Krok 4: dokončená montáž

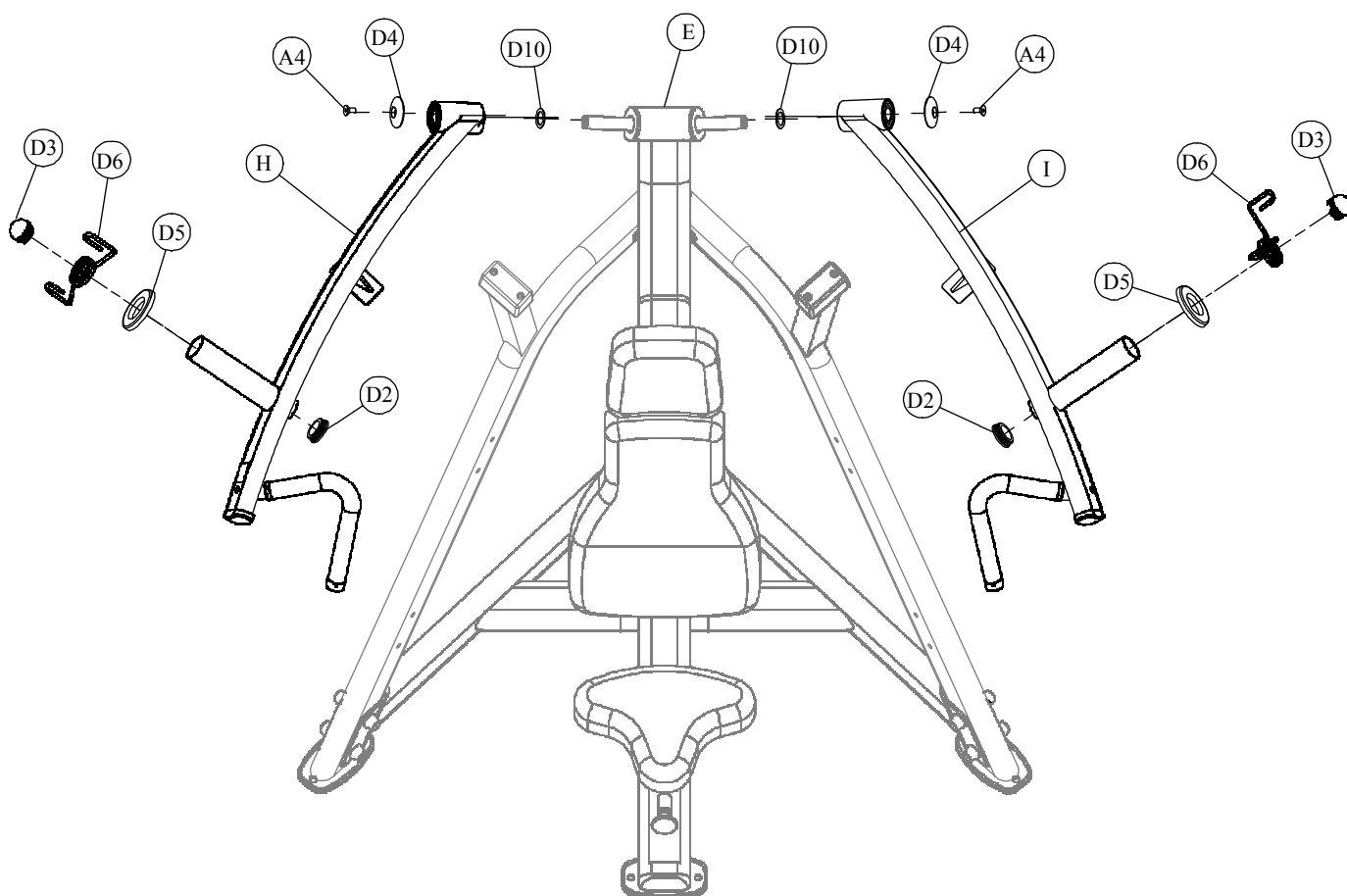

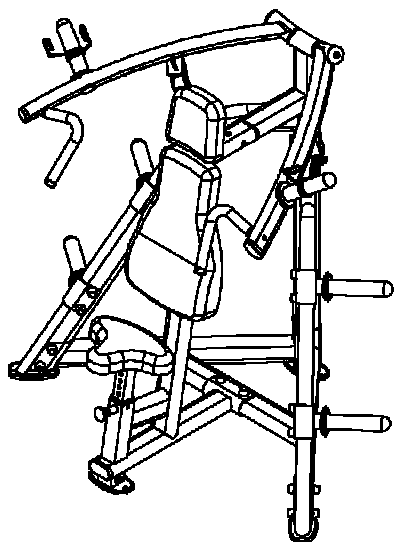

Krok 5: dokončená montáž

